

SPECIFICATION FOR LCD MODULE

MODULE NO: YB-TG800320S01A-N-A0

Doc.Version:00

Customer Approval:

<input type="checkbox"/> Accept	<input type="checkbox"/> Reject
---------------------------------	---------------------------------

YEEBO	NAME	SIGNATURE	DATE
Prepare	Electronic Engineer	任强琛	2020/1/10
Check	Mechanical Engineer	赵健强	2020/1/10
Verify		邱若刚	2020/1/10
Approval		何不盈	2020/1/10

APPROVAL FOR SPECIFICATIONS ONLY

APPROVAL FOR SPECIFICATIONS AND SAMPLE

WIMRD005-02-D

2. Table of Contents:

NO	CONTENTS	PAGE
1	Revision History	1
2	Table of Contents	2
3	Module Numbering System	3
4	General Specification	4
5	LCM drawing	5
6	Electrical Characteristics	6
7	Optical Characteristics	9
8	Interface Pin Assignment	11
9	Block Diagram	12
10	Backlight	13
11	Standard Specification for Reliability	14
12	Specification of Quality Assurance	16
13	Handling Precaution	24
14	Warranty	25
15	Guarantee	25

3. Module Numbering System:

YB-TG240320S01D-T-A0

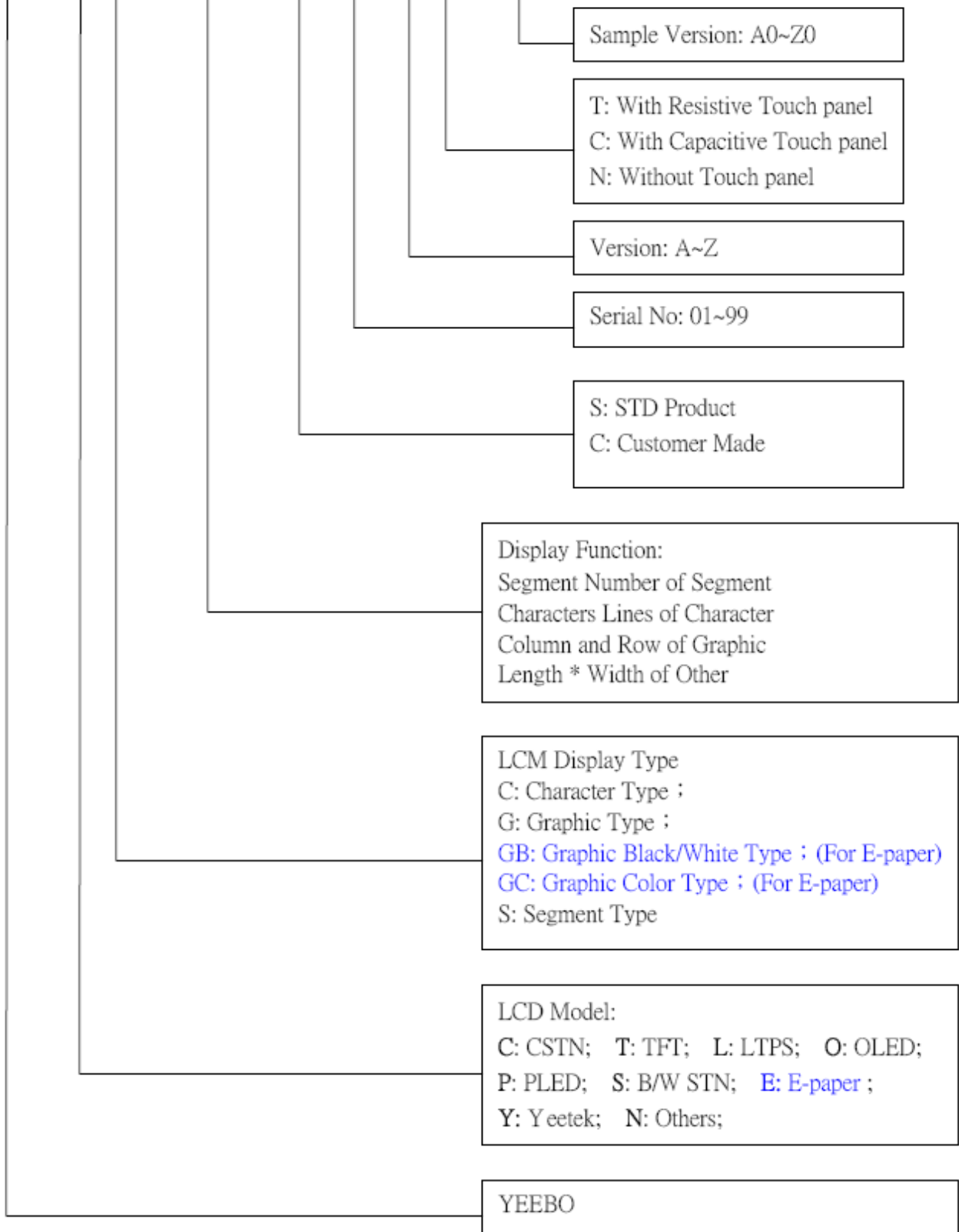

4. General Specification:

ITEM	CONTENTS
Module Size	120.7(W) * 54.7(H) * 2.9(T) mm
Module Size(With FPC)	120.7(W) *104.28 (H) * 2.9(T) mm
Display Size	4.6 inch
Display Format	800(RGB)* 320 WVGA
Active Area	108.0(W) * 43.2(H) mm
LCD Type	Active matrix TFT/ Transmissive
Input Data	24 bit RGB interface
Viewing Direction (Gray inversion)	6 O'clock
The Best Viewing Direction	12 O'clock
Source Drive IC	HX8264D or Compatible
Gate Drive IC	HX8664B or Compatible
Weight	TBD

5. LCM drawing:

Rec. #1	Count drawing & Spec. revision record during discussion with customer	Date
	Revision content description	
	FIRST ISSUE	2020-01-10

- Specification:**
1. Display mode: 4.6" TFT/ Transmissive /Normally White
 2. Display Color: 16M
 3. Viewing Direction: 6 O'clock
 4. Gate Drive IC: HX6664B or Compatible
 5. Source Drive IC: HX6264D or Compatible
 6. Backlight: LED White (x12)
 7. Unspecified tolerance: ±0.30mm.
 8. ROHS compliant

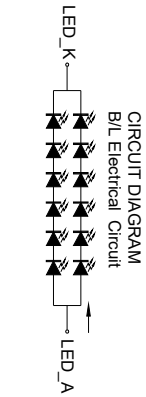

		MOD. Name	YB-TG800320S01A-N-A	FILE NAME	Count Dwg.
UNIT	mm	DESIGNED	赵健强	VERIFIED	
SIZE	A4	CHECKED		APPROVED	
SCALE	N-T-S	SCALE	2020-01-10		
		Sheet	1	Of	1

Detail: "A"
Scale: 1.00X

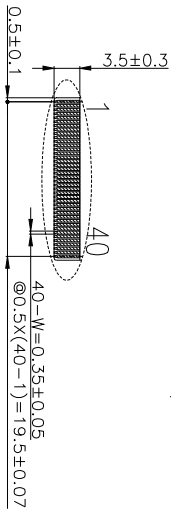

Detail: "B"
Scale: 2X

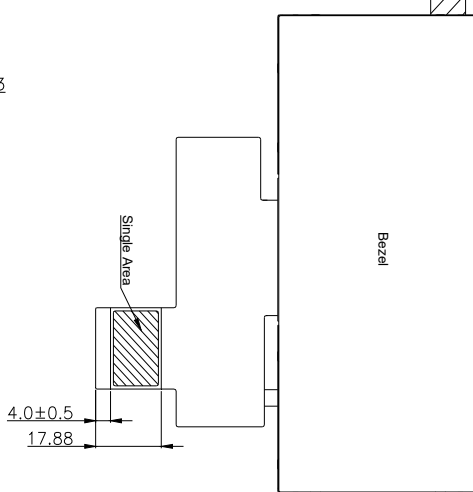
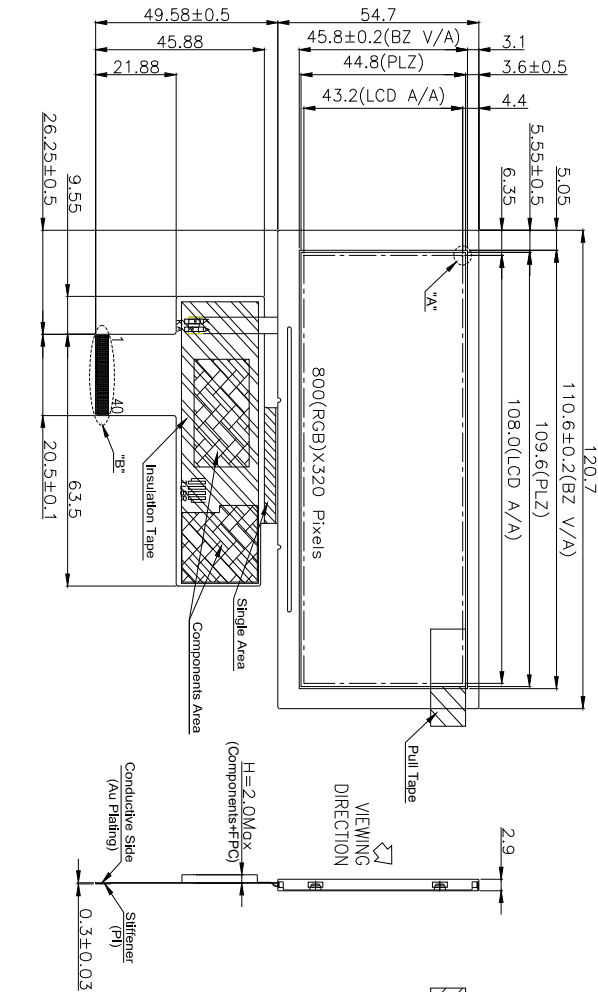

1	LED_K	LED K
2	LED_A	LED A
3	GND	
4	VDD	
5	R0	
6	R1	
7	R2	
8	R3	
9	R4	
10	R5	
11	R6	
12	R7	
13	G0	
14	G1	
15	G2	
16	G3	
17	G4	
18	G5	
19	G6	
20	G7	
21	B0	
22	B1	
23	B2	
24	B3	
25	B4	
26	B5	
27	B6	
28	B7	
29	GND	
30	DCLK	
31	DISP	
32	HSYNC	
33	VSYNC	
34	DE	
35	NC	
36	GND	
37	NC	
38	NC	
39	NC	
40	NC	

6. Electrical Characteristics:

6-1 Absolute Maximum Ratings

TFT IC HX8264D+HX8664B

(Ta=25°C)

Item	Symbol	Min.	Type	Max.	Unit	Remark
Power Voltage	VDD	-0.5	-	+3.96	V	Note1 Note2
Operating Temperature	TOPR	-20	-	+70	°C	Note1 Note2
Storage Temperature	TSTR	-30	-	+80	°C	Note1 Note2

Note 1: The driver IC may be permanently damaged if it is used under the condition exceeding the above absolute maximum values. It is also recommended to use the driver IC within the limit of its electric characteristics during normal operation. Exceeding the conditions may lead to malfunction of it and affect its credibility.

Note 2: The voltage from GND.

6-2 Electrical Characteristics

TFT IC HX8264D+HX8664B

(Ta=25°C)

Item	Symbol	Rating			Unit	Remark
		Min	Typ	Max		
Power Voltage Logic	VDD	3.0	3.3	3.6	V	Note 1
Input voltage L level	VIL	GND	-	0.3*VDD	V	VDD=3.0 ~3.6V
Input voltage H level	VIH	0.7* VDD	-	VDD	V	
LCD Drive Power current	ILCD	-	TBD	-	mA	VDD= 3.3V

Note1:

Vcom must be adjusted to optimize display quality: Cross-talk, Contrast Ratio and etc.

6-3 Timing Characteristics

6-3-1 TFT IC HX8264D+HX8664B Data Input Format

Vertical input timing

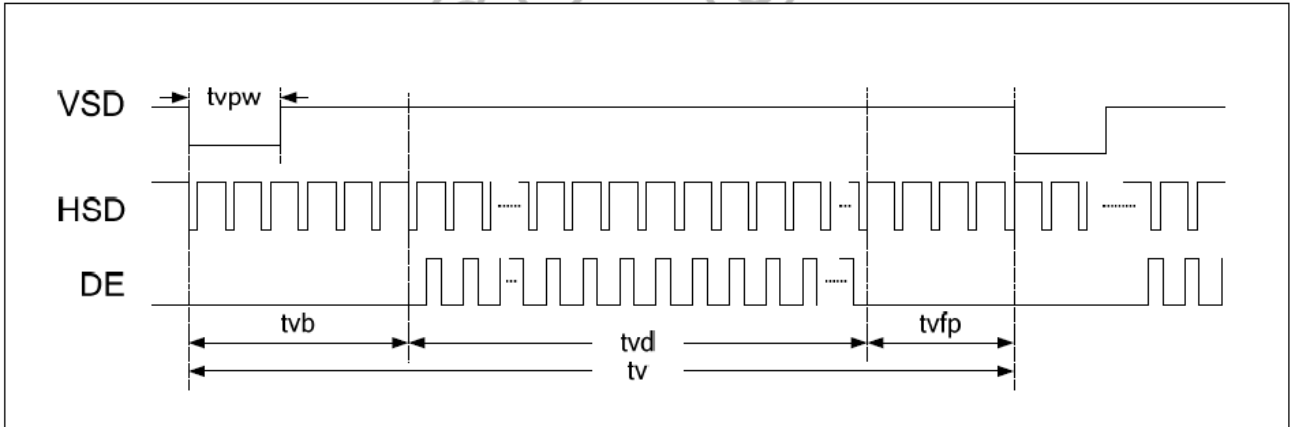

Horizontal input timing

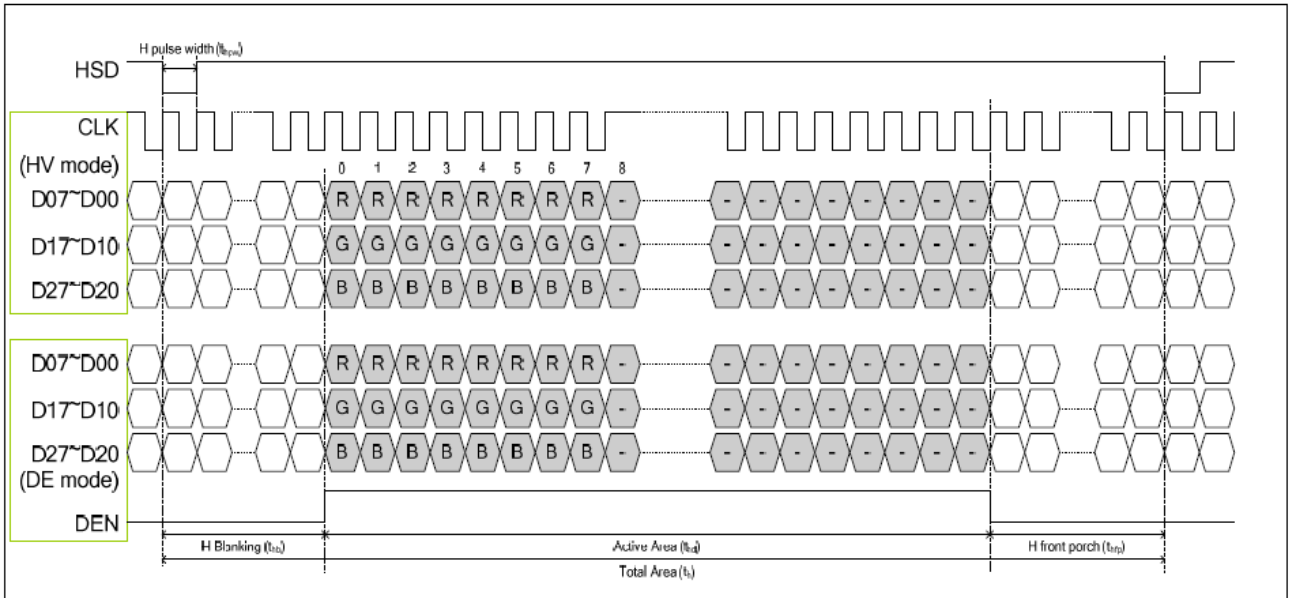

6-3-2 TFT IC HX8264D+HX8664B Timing Conditions

Resolution : 800x480

- Horizontal timing

Parameter	Symbol	Spec.			Unit
		Min.	Typ.	Max.	
Horizontal Display Area	thd	800			DCLK
DCLK frequency	fclk	-	30	50	MHz
One Horizontal Line	th	889	928	1143	DCLK
HS pulse width	thpw	1	48	255	DCLK
HS Back Porch (Blanking)	thb	88			DCLK
HS Front Porch	thfp	1	40	255	DCLK
DE mode Blanking	th-thd	85	128	512	DCLK

- Vertical timing

Parameter	Symbol	Spec.			Unit
		Min.	Typ.	Max.	
Vertical Display Area	tvd	480			T _H
VS period time	tv	513	525	767	T _H
VS pulse width	tvpw	3	3	255	T _H
VS Back Porch (Blanking)	tvb	32			T _H
VS Front Porch	tvfp	1	13	255	T _H
DE mode Blanking	tv-tvd	4	45	255	T _H

7. Optical Characteristics:

Item	Symbol	Conditions	Specifications			Unit	Note	
			Min	Typ	Max			
Transmittance	T(%)	-	4.0	4.3	-	%	-	
Contrast Ratio	CR	$\Theta=0$ Normal Viewing angle	350	500	-		(1) (2)	
Response time	TR+TF	-	-	25	-	ms	(1) (3)	
Viewing angle	Hor.	Θ_{x+}	CR ≥ 10	-	65	-	deg.	(1)
		Θ_{x-}		-	65	-		
	Ver.	Θ_{y+}		-	50	-		
		Θ_{y-}		-	60	-		

Measuring Condition

1. Measuring surrounding: dark room
2. Ambient temperature: $25 \pm 2^{\circ}\text{C}$
3. 30 min. Warm-up time.

Color of CIE Coordinate:

Item	Symbol	Condition	Min.	Typ.	Max.	
Chromaticity Coordinates (Transmissive)	Red	x	TBD	0.5908	TBD	
		y	TBD	0.3155	TBD	
	Green	x	$\theta = \phi = 0^{\circ}$ LED Backlight	TBD	0.3450	TBD
		y		TBD	0.5260	TBD
	Blue	x		TBD	0.1467	TBD
		y		TBD	0.0899	TBD
	White	x		TBD	0.2839	TBD
		y		TBD	0.3098	TBD

Note (1) Definition of Viewing Angle :

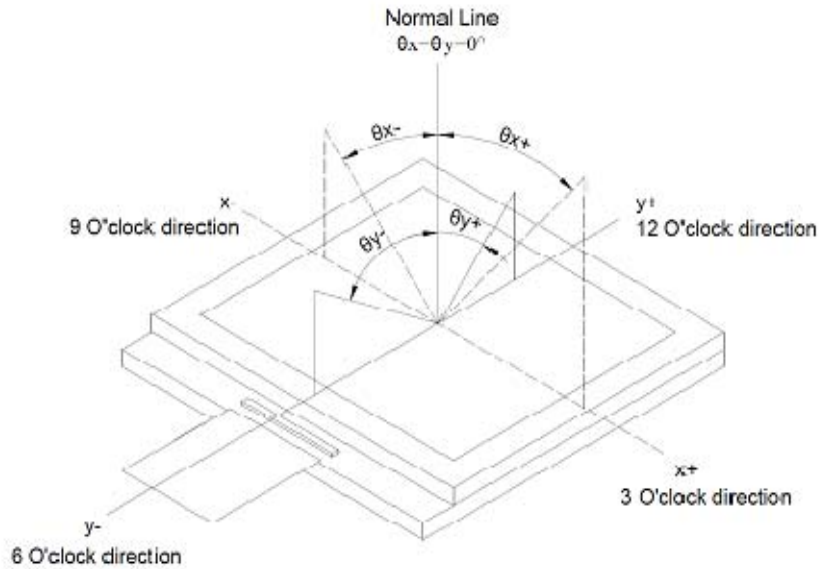

Note (2) Definition of Contrast Ratio(CR) :
measured at the center point of panel

$$\text{Contrast ratio (CR)} = \frac{\text{Photo detector output when LCD is at "White" state}}{\text{Photo detector output when LCD is at "Black" state}}$$

Note (3) Definition of Response Time : Sum of TR and TF

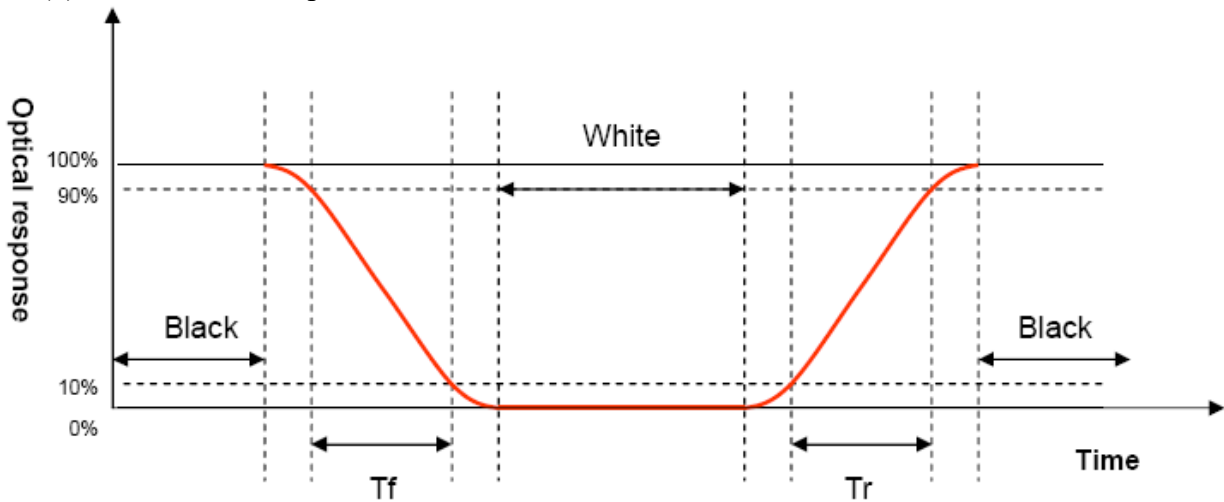

8. Interface Pin Assignment:

PIN NO.	Symbol	I/O	Description
1	K	P	Power for LED backlight cathode
2	A	P	Power for LED backlight anode
3	GND	P	Power ground
4	VDD	P	Power voltage
5~12	R0~R7	I	Red data
13~20	G0~G7	I	Green data
21~28	B0~B7	I	Blue data
29	GND	P	Power ground
30	DCLK(Positive)	I	Pixel clock, latch data at CLKIN rising edge.
31	DISP	I	Display on/off , normally pulled high
32	HSYNC (HSD)	I	Horizontal sync signal If not used, fix this pin at VDD
33	VSYNC (VSD)	I	Vertical sync signal If not used, fix this pin at VDD
34	DEN (DE)	I	Data enable (active High)
35	NC	-	No connect
36	GND	P	Power ground
37	NC	-	No connect
38	NC	-	No connect
39	NC	-	No connect
40	NC	-	No connect

9. Back Diagram :

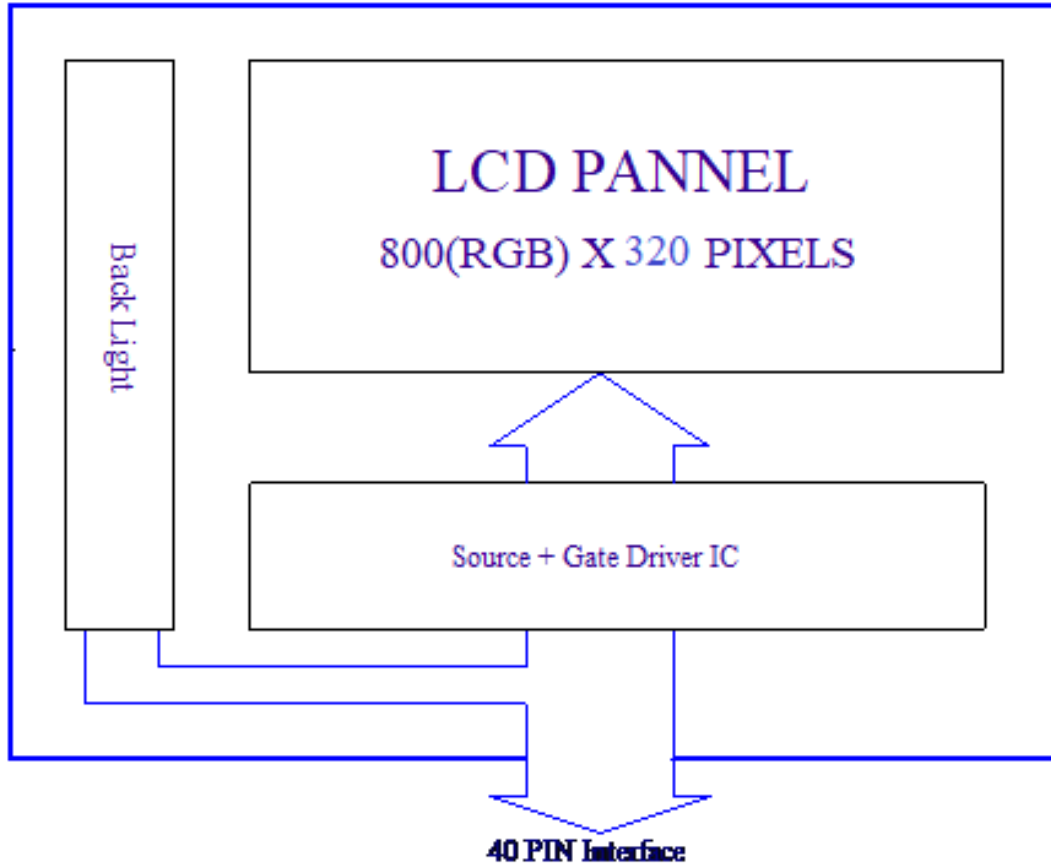

10. Backlight:

1. Standard Lamp Styles (Edge Lighting Type):
The LED chips are distributed over the edge light area of the illumination unit, which gives the less power consumption:
2. The Main Advantages of the LED Backlight are as following:
 - 2.1 The brightness of the backlight can simply be adjusted.
By a resistor or a potentiometer.

3. Data About LED Backlight:

(Ta=25°C)

PARAMETER	Sym.	Min.	Typ.	Max.	Unit	Test Condition	Note
Supply Voltage	V	16.2	18.6	21.0	V	If=40mA	
Luminous Intensity for LCM	IV	300	350	-	Cd/m ²	If=40mA	2
Uniformity for LCM	-	70	-	-	%		3
Life Time	-	20000	-	-	Hr.		4
Color	White						

NOTE:

1. Backlight Only
2. Average Luminous Intensity of P1-P9
3. Uniformity = Min/Max * 100%
4. LED life time defined as follows: The final brightness is at 50% of original brightness

Internal Circuit Diagram

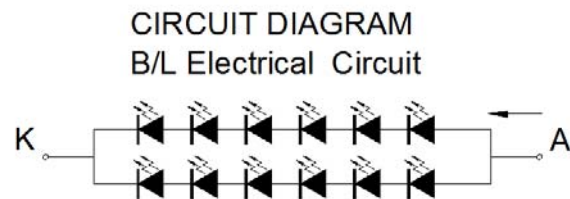
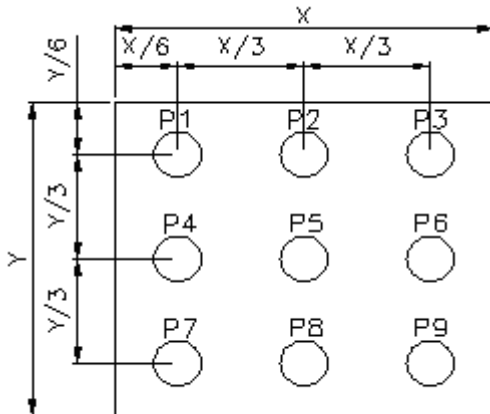

(Effective spatial Distribution)

Using aperture of 1°, distance 50cm.

11. Standard Specification for Reliability .:

11-1. Standard Specifications for Reliability of LCD Module

No	Item	Description
01	High temperature operation	The sample should be allowed to stand at 70°C for 120 hours under driving condition and then returning it to normal temperature condition, and allowing it stand for 2 hours.
02	Low temperature operation	The sample should be allowed to stand at -20°C for 120 hours under driving condition and then returning it to normal temperature condition, and allowing it stand for 2 hours.
03	High temperature storage	The sample should be allowed to stand at 80°C for 240 hours under no-load condition, and then returning it to normal temperature condition, and allowing it stand for 2 hours.
04	Low temperature storage	The sample should be allowed to stand at -30°C for 240 hours under no-load condition, then returning it to normal temperature condition, and allowing it stand for 2 hours.
05	Moisture storage	The sample should be allowed to stand at 60°C,90%RH MAX for 240 hours under no-load condition, then taking it out and drying it at normal temperature for 2 hours.
06	Thermal shock storage	The sample should be allowed to stand the following 10 cycles : -30°C for 30 minutes → normal temperature for 5 minutes → +80°C for 30 minutes → normal temperature for 5 minutes, as one cycle.
07	Packing vibration	Frequency range : 10Hz ~ 55Hz Amplitude of vibration : 1.5mm Sweep time: 12 min X,Y,Z 2 hours for each direction.
08	Packing drop test	According to ISTA 1A 2001.
09	Electrical Static Discharge	Air: ±6KV 150pF/330Ω 5 times
		Contact: ±4KV 150pF/330Ω 5 time

*Sample size for each test item is 3~5pcs

11 - 2. Testing Conditions and Inspection Criteria

For the final test the testing sample must be stored at room temperature for 24 hours, after the tests listed in Table 12.2, Standard specifications for Reliability have been executed in order to ensure stability.

No	Item	Test Model	In section Criteria
01	Current Consumption	Refer To Specification	The current consumption should conform to the product specification.
02	Contrast	Refer To Specification	After the tests have been executed, the contrast must be larger than half of its initial value prior to the tests.
03	Appearance	Visual inspection	Defect free.

11- 3. MTBF

MTBF	Functions, performance, appearance, etc. shall be free from remarkable deterioration within 50,000 hours under ordinary operating and storage conditions room temperature (25±5°C), normal humidity (50±10% RH), and in area not exposed to direct sun light.
------	---

12. Specification of Quality Assurance:

12-1. Purpose

This standard for Quality Assurance should affirm the quality of LCD module products to supply to purchaser by YEEBO CORPORATION (Supplier).

12-2. Standard for Quality Test

a. Inspection:

Before delivering, the supplier should take the following tests, and affirm the quality of product.

b. Electro-Optical Characteristics:

According to the individual specification to test the product.

c. Test of Appearance Characteristics:

According to the individual specification to test the product.

d. Test of Reliability Characteristics:

According to the definition of reliability on the specification for testing products.

e. Delivery Test:

Before delivering, the supplier should take the delivery test.

(i) Test method: According to **ISO2859-1**.General Inspection Level II take a single time.

(ii) The defects classify of AQL as following:

Major defect: AQL = 0.65

Minor defect: AQL = 2.5

Total defects: AQL = 2.5

12-3. Non- conforming Analysis & Deal With Manners

a. Non- conforming Analysis:

(i) Purchaser should supply the detail data of non- conforming sample and the non-conforming.

(ii) After accepting the detail data from purchaser, the analysis of non- conforming should be finished in two weeks.

(iii) If supplier can not finish analysis on time, must announce purchaser before 3 days.

b. Disposition of non- conforming:

(i) If find any product defect of supplier during assembly time, supplier must change the good product for every defect after recognition.

(ii) Both supplier and customer should analyze the reason and discuss the disposition of non- conforming when the reason of nonconforming is not sure.

12-4. Agreement items

Both sides should discuss together when the following problems happen.

a. There is any problem of standard of quality assurance, and both sides should think that must be modified.

b. There is any argument item which does not record in the standard of quality assurance.

c. Any other special problem.

12-5. Standard of The Product Appearance Test

a. Manner of appearance test:

(i) The test must be under 20W × 2 or 40W fluorescent light, and the distance of view must be at 30±5cm.

(ii) When test the model of transmissive product must add the reflective plate.

(iii) The test direction is base on around 10° of vertical line.

(iii) Temperature: 25±5°C Humidity: 60±10%RH

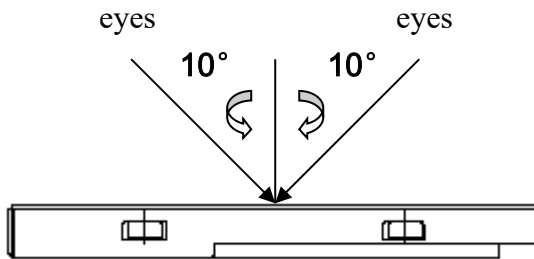

(iv) Definition of area:

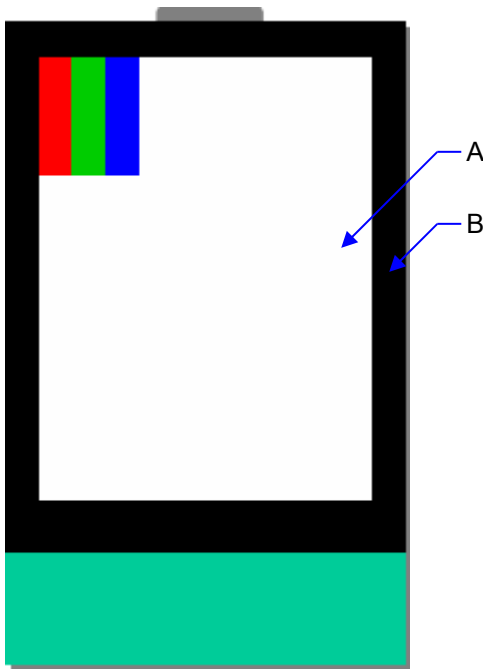

A. Area: Viewing area.

B. Area: Out of viewing area.

(Outside viewing area)

b. Basic principle:

(i) It will accord to the AQL when the standard can not be described.

(ii) The sample of the lowest acceptable quality level must be discussed by both supplier and customer when any dispute happened.

(iii) Must add new item on time when it is necessary.

c. Standard of inspection: (Unit: mm)

12-6. Inspection specification
Defect out of viewing area can be neglected.

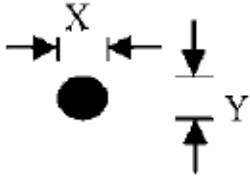
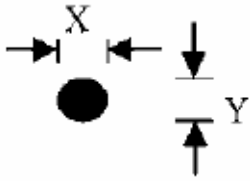
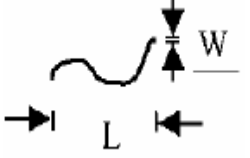
NO	Item	Criterion	AQL													
01	Electrical Testing	1.1 Missing vertical, horizontal segment, segment contrast defect. 1.2 Missing character, dot or icon. 1.3 Display malfunction. 1.4 No function or no display. 1.5 Current consumption exceeds product specifications. 1.6 LCD viewing angle defect. 1.7 Mixed product types. 1.8 Flicker	0.65													
02	Black or White spots or Bright spots or Color spots on LCD (Display only)	2.1 Dot dimension as below drawing: $\Phi = (X+Y) / 2$  <table border="1" data-bbox="758 772 1292 963"> <thead> <tr> <th>Size(mm)</th> <th>Acceptable Q'ty</th> </tr> </thead> <tbody> <tr> <td>$\Phi \leq 0.20$</td> <td>Accept no dense</td> </tr> <tr> <td>$0.20 < \Phi \leq 0.40$</td> <td>5</td> </tr> <tr> <td>$0.40 < \Phi$</td> <td>0</td> </tr> </tbody> </table> 2.2 Not visible through 5% ND filter * Densely spaced: No more than two spots within 3mm.	Size(mm)	Acceptable Q'ty	$\Phi \leq 0.20$	Accept no dense	$0.20 < \Phi \leq 0.40$	5	$0.40 < \Phi$	0	2.5					
Size(mm)	Acceptable Q'ty															
$\Phi \leq 0.20$	Accept no dense															
$0.20 < \Phi \leq 0.40$	5															
$0.40 < \Phi$	0															
03	LCD and Touch Panel black spots, white spots, contamination (non – display)	3.1 Round type: As following drawing $\Phi = (X+Y) / 2$  <table border="1" data-bbox="758 1198 1292 1388"> <thead> <tr> <th>Size(mm)</th> <th>Acceptable Q'ty</th> </tr> </thead> <tbody> <tr> <td>$\Phi \leq 0.20$</td> <td>Accept no dense</td> </tr> <tr> <td>$0.20 < \Phi \leq 0.40$</td> <td>5</td> </tr> <tr> <td>$0.40 < \Phi$</td> <td>0</td> </tr> </tbody> </table> * Densely spaced: No more than two spots within 3mm.	Size(mm)	Acceptable Q'ty	$\Phi \leq 0.20$	Accept no dense	$0.20 < \Phi \leq 0.40$	5	$0.40 < \Phi$	0	2.5					
		Size(mm)	Acceptable Q'ty													
$\Phi \leq 0.20$	Accept no dense															
$0.20 < \Phi \leq 0.40$	5															
$0.40 < \Phi$	0															
3.2 Line type: (As following drawing)  <table border="1" data-bbox="662 1556 1292 1915"> <thead> <tr> <th>Length(mm)</th> <th>Width(mm)</th> <th>Acceptable Q'ty</th> </tr> </thead> <tbody> <tr> <td>$L \leq 10$</td> <td>$W \leq 0.1$</td> <td>Accept no dense</td> </tr> <tr> <td>$L \leq 10.0$</td> <td>$0.1 < W \leq 0.25$</td> <td>4</td> </tr> <tr> <td>$L > 10$</td> <td>----</td> <td>Rejection</td> </tr> <tr> <td>----</td> <td>$0.25 < W$</td> <td>Rejection</td> </tr> </tbody> </table> * Densely spaced: No more than two lines within 3mm.	Length(mm)	Width(mm)	Acceptable Q'ty	$L \leq 10$	$W \leq 0.1$	Accept no dense	$L \leq 10.0$	$0.1 < W \leq 0.25$	4	$L > 10$	----	Rejection	----	$0.25 < W$	Rejection	2.5
Length(mm)	Width(mm)	Acceptable Q'ty														
$L \leq 10$	$W \leq 0.1$	Accept no dense														
$L \leq 10.0$	$0.1 < W \leq 0.25$	4														
$L > 10$	----	Rejection														
----	$0.25 < W$	Rejection														

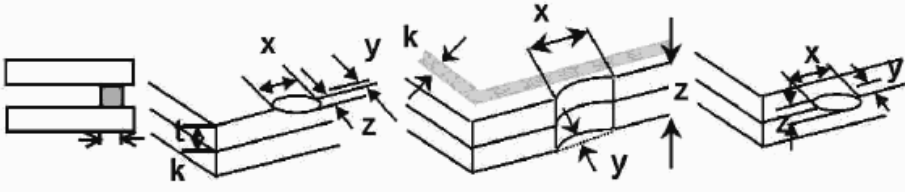
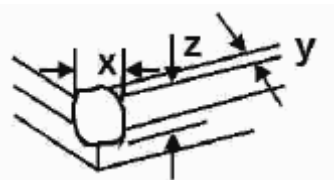
NO	Item	Criterion	AQL																		
04	Polarizer bubbles	<p>If bubbles are visible, judge using black spot specifications, not easy to find, must check in specify direction</p> <table border="1"> <thead> <tr> <th>Size Φ(mm)</th> <th>Acceptable Q'ty</th> </tr> </thead> <tbody> <tr> <td>$\Phi \leq 0.20$</td> <td>Accept no dense</td> </tr> <tr> <td>$0.20 < \Phi \leq 0.50$</td> <td>4</td> </tr> <tr> <td>$0.50 < \Phi \leq 1.00$</td> <td>3</td> </tr> <tr> <td>$1.00 < \Phi$</td> <td>0</td> </tr> <tr> <td>Total Q'ty</td> <td>4</td> </tr> </tbody> </table>	Size Φ (mm)	Acceptable Q'ty	$\Phi \leq 0.20$	Accept no dense	$0.20 < \Phi \leq 0.50$	4	$0.50 < \Phi \leq 1.00$	3	$1.00 < \Phi$	0	Total Q'ty	4	2.5						
Size Φ (mm)	Acceptable Q'ty																				
$\Phi \leq 0.20$	Accept no dense																				
$0.20 < \Phi \leq 0.50$	4																				
$0.50 < \Phi \leq 1.00$	3																				
$1.00 < \Phi$	0																				
Total Q'ty	4																				
05	Scratches	Follow NO.3 -2 Line Type.																			
06	Mura	Not visible through 5% ND filter in 50% gray.	2.5																		
07	Chipped glass	<p>Symbols: x: Chip length y: Chip width z: Chip thickness k: Seal width t: Glass thickness a: LCD side length L: Electrode pad length</p> <p>7.1 General glass chip: 7.1.1 Chip on panel surface and crack between panels:</p>  <table border="1"> <thead> <tr> <th>z: Chip thickness</th> <th>y: Chip width</th> <th>x: Chip length</th> </tr> </thead> <tbody> <tr> <td>$Z \leq 1/2t$</td> <td>Not over viewing area</td> <td>$x \leq 1/8a$</td> </tr> <tr> <td>$1/2t < z \leq 2t$</td> <td>Not exceed 1/3k</td> <td>$x \leq 1/8a$</td> </tr> </tbody> </table> <p>mm ⊙ If there are 2 or more chips, x is the total length of each chip</p> <p>7.1.2 Corner crack:</p>  <table border="1"> <thead> <tr> <th>z: Chip thickness</th> <th>y: Chip width</th> <th>x: Chip length</th> </tr> </thead> <tbody> <tr> <td>$Z \leq 1/2t$</td> <td>Not over viewing area</td> <td>$x \leq 1/8a$</td> </tr> <tr> <td>$1/2t < z \leq 2t$</td> <td>Not exceed 1/3k</td> <td>$x \leq 1/8a$</td> </tr> </tbody> </table> <p>mm ⊙ If there are 2 or more chips, x is the total length of each chip</p>	z: Chip thickness	y: Chip width	x: Chip length	$Z \leq 1/2t$	Not over viewing area	$x \leq 1/8a$	$1/2t < z \leq 2t$	Not exceed 1/3k	$x \leq 1/8a$	z: Chip thickness	y: Chip width	x: Chip length	$Z \leq 1/2t$	Not over viewing area	$x \leq 1/8a$	$1/2t < z \leq 2t$	Not exceed 1/3k	$x \leq 1/8a$	2.5
z: Chip thickness	y: Chip width	x: Chip length																			
$Z \leq 1/2t$	Not over viewing area	$x \leq 1/8a$																			
$1/2t < z \leq 2t$	Not exceed 1/3k	$x \leq 1/8a$																			
z: Chip thickness	y: Chip width	x: Chip length																			
$Z \leq 1/2t$	Not over viewing area	$x \leq 1/8a$																			
$1/2t < z \leq 2t$	Not exceed 1/3k	$x \leq 1/8a$																			

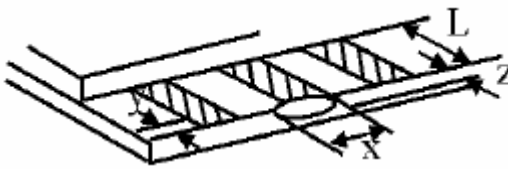
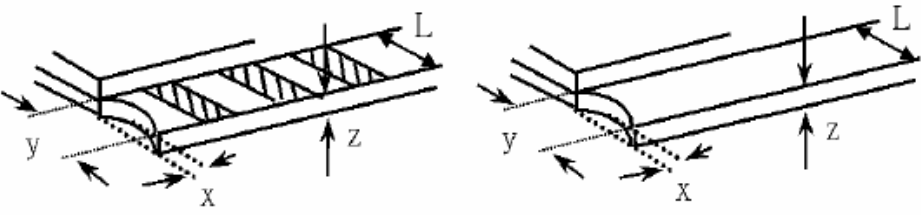
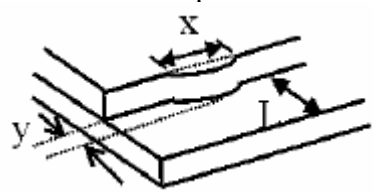
NO	Item	Criterion	AQL																
08	Glass crack	<p>Symbols: x: Chip length y: Chip width z: Chip thickness k: Seal width t: Glass thickness a: LCD side length L: Electrode pad length</p> <p>8.1 Protrusion over terminal: 8.1.1 Chip on electrode pad:</p>  <table border="1" data-bbox="486 694 1173 862"> <tr> <td>y: Chip width</td> <td>x: Chip length</td> <td>z: Chip thickness</td> </tr> <tr> <td>$y \leq 0.5\text{mm}$</td> <td>$x \leq 1/8a$</td> <td>$0 < z \leq t$</td> </tr> </table> <p>8.1.2 Non-conductive portion:</p>  <table border="1" data-bbox="486 1209 1173 1377"> <tr> <td>y: Chip width</td> <td>x: Chip length</td> <td>z: Chip thickness</td> </tr> <tr> <td>$y \leq L$</td> <td>$x \leq 1/8a$</td> <td>$0 < z \leq t$</td> </tr> </table> <p>⊙ If there chipped area touches the ITO terminal, over 2/3 of the ITO must remain and be inspected according to electrode terminal specifications.</p> <p>⊙ If the product will be heat sealed by the customer, the alignment mark must not be damaged.</p> <p>8.1.3 Substrate protuberance and internal crack</p>  <table border="1" data-bbox="805 1713 1244 1870"> <tr> <td>y: width</td> <td>x: length</td> </tr> <tr> <td>$y \leq 1/3L$</td> <td>$X \leq a$</td> </tr> </table>	y: Chip width	x: Chip length	z: Chip thickness	$y \leq 0.5\text{mm}$	$x \leq 1/8a$	$0 < z \leq t$	y: Chip width	x: Chip length	z: Chip thickness	$y \leq L$	$x \leq 1/8a$	$0 < z \leq t$	y: width	x: length	$y \leq 1/3L$	$X \leq a$	2.5
y: Chip width	x: Chip length	z: Chip thickness																	
$y \leq 0.5\text{mm}$	$x \leq 1/8a$	$0 < z \leq t$																	
y: Chip width	x: Chip length	z: Chip thickness																	
$y \leq L$	$x \leq 1/8a$	$0 < z \leq t$																	
y: width	x: length																		
$y \leq 1/3L$	$X \leq a$																		

NO	Item	Criterion	AQL
09	Cracked glass	The LCD with extensive crack is not acceptable.	2.5
10	Backlight elements	10.1 Illumination source flickers when lit. 10.2 Spots or scratches that appear when lit must be judged. Using LCD spot, lines and contamination standards. 10.3 Backlight doesn't light or color is wrong.	2.5 2.5 0.65
11	Bezel	Bezel must comply with product specifications.	2.5
12	PCB、COB	12.1 COB seal may not have pinholes larger than 0.2mm or contamination. 12.2 COB seal surface may not have pinholes through to the IC. 12.3 The height of the COB should not exceed the height indicated in the assembly diagram. 12.4 There may not be more than 2mm of sealant outside the seal area on PCB. And there should be no more than three places. 12.5 Parts on PCB must be the same as on the production characteristic chart, There should be no wrong parts, missing parts or excess parts. 12.6 The jumper on the PCB should conform to the product characteristic chart.	2.5 2.5 2.5 2.5 0.65 0.65
13	FPC	13.1 FPC terminal damage \leq 1/2 FPC terminal width and can not affect the function , we judge accept. 13.2 FPC alignment hole damage \leq 1/2 alignment area and can not affect the function , we judge accept.	2.5 2.5
14	Soldering	14.1 No cold solder joints, missing solder connections, oxidation or icide. 14.2 No short circuits in components on PCB or FPC.	2.5 0.65

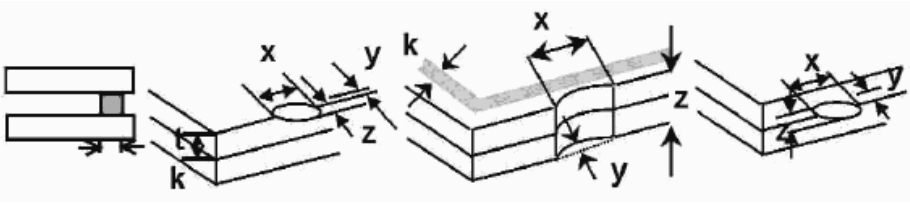
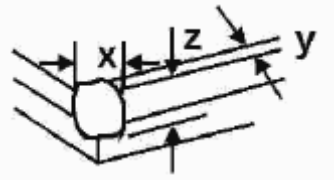
NO	Item	Criterion	AQL												
15	Touch Panel Chipped glass	<p>Symbols: x: Chip length y: Chip width z: Chip thickness k: Seal width t: Touch Panel Total thickness a: LCD side length L: Electrode pad length</p> <p>15.1 General glass chip: 15.1.1 Chip on panel surface and crack between panels:</p>  <table border="1" data-bbox="343 817 1161 1034"> <tr> <td>z: Chip thickness</td> <td>y: Chip width</td> <td>x: Chip length</td> </tr> <tr> <td>$z \leq t$</td> <td>$\leq 1/2 k$ and not over viewing area</td> <td>$x \leq 1/8a$</td> </tr> </table> <p>⊙ Unit: mm ⊙ If there are 2 or more chips, x is the total length of each chip</p> <p>15.1.2 Corner crack:</p>  <table border="1" data-bbox="343 1444 1161 1662"> <tr> <td>z: Chip thickness</td> <td>y: Chip width</td> <td>x: Chip length</td> </tr> <tr> <td>$z \leq t$</td> <td>$\leq 1/2 k$ and not over viewing area</td> <td>$x \leq 1/8a$</td> </tr> </table> <p>⊙ Unit: mm ⊙ If there are 2 or more chips, x is the total length of each chip</p>	z: Chip thickness	y: Chip width	x: Chip length	$z \leq t$	$\leq 1/2 k$ and not over viewing area	$x \leq 1/8a$	z: Chip thickness	y: Chip width	x: Chip length	$z \leq t$	$\leq 1/2 k$ and not over viewing area	$x \leq 1/8a$	2.5
z: Chip thickness	y: Chip width	x: Chip length													
$z \leq t$	$\leq 1/2 k$ and not over viewing area	$x \leq 1/8a$													
z: Chip thickness	y: Chip width	x: Chip length													
$z \leq t$	$\leq 1/2 k$ and not over viewing area	$x \leq 1/8a$													

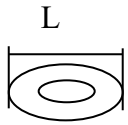
NO	Item	Criterion	AQL		
16	Touch Panel(Fish eye)	SIZE(mm)	Acceptable Q'ty		2.5
		$L \leq 0.7$	Accept no dense		
		$L > 0.7\text{mm}$	0		
17	Touch Panel Newton ring	Newton ring dimension $\leq 1/2$ touch panel area and not affect font and line distortion($\leq 2.5\%$) , it is acceptable.	2.5		
18	Touch Panel Linearity	Less than 2.5% is acceptable.	2.5		
19	LCD Ripple	Touch the touch panel , can not see the LCD ripple. Pen: R 1.0mm silicon rubber. Operation Force: 80g	2.5		
20	General appearance	20.1 Pin type must match type in specification sheet.	0.65		
		20.2 LCD pin loose or missing pins.	0.65		
		20.3 Product packaging must the same as specified on packaging specification sheet.	0.65		
		20.4 Product dimension and structure must conform to product specification sheet.	0.65		

13. Handling Precaution:

13-1 Handling of LCM

- Don't give external shock.
- Don't apply excessive force on the surface.
- Liquid in LCD is hazardous substance. Must not lick and swallow. when the liquid is attach to your hand, skin, cloth etc. Wash it out thoroughly and immediately.
- Don't operate it above the absolute maximum rating.
- Don't disassemble the LCM.
- The operators should be grounded whenever he/she comes into contact with the module. Never touch any of the conductive parts such as the LSI pads, the copper leads on the PCB and the interface terminals with any parts of the human body.
- The modules should be kept in antistatic bags or other containers resistant to static for storage.
- The module is coated with a film to protect the display surface. Be care when peeling off this protective film since static electricity may be generated.

13-2 Storage

- Store in an ambient temperature of $25\pm 10^{\circ}\text{C}$, and in a relative humidity of $50\pm 10\%\text{RH}$. Don't expose to sunlight or fluorescent light.
- Storage in a clean environment, free from dust, active gas, and solvent.
- Store in anti-static electricity container.
- Store without any physical load.

13-3 Soldering

- Use only soldering irons with proper grounding and no leakage.
- Iron: No higher than $310\pm 10^{\circ}\text{C}$ and less than 3 sec during Hand soldering.
- Rewiring: no more than 2 times.

14. Warranty

This product has been manufactured to specifications as a part for use in your company's general electronic products. It is guaranteed to perform according to delivery specifications. For any other use apart from general electronic equipment, we will not take responsibility if the product is used in medical devices, nuclear power control equipment, aerospace equipment, fire and security systems, or any other applications in which there is a direct risk to human life and where extremely high levels of reliability are required. If the product is to be used in any of the above applications, we will need to enter into a separate product liability agreement.

1. We cannot accept responsibility for any defect arise after additional process of the product (including disassembly and reassembly), after product delivery.
2. We cannot accept responsibility for any defect, which may arise after the application of strong external force to the product.
3. We cannot accept responsibility for any defect, which may arise due to the application of static electricity after the product has passed your company's acceptance inspection procedures.
4. We can not accept responsibility for industrial property, which may arise through the use of your product , with exception to those issues relating directly to the structure or method of manufacturing of our product within one year from YEEBO shipment.
5. For Heatseal Product which required to heatseal by customer side, parts must be used within three months after delivery from factory.
6. For TAB Product which required to solder by customer side, parts must be used within three months after delivery from factory.
7. The liability of YB is limited to repair or replacement on the terms set forth below. YB will not be responsible for any subsequent or consequential events or injury or damage to any personnel or user including third party personnel and/or user. Unless otherwise agreed in writing between YB and the customer, YB will only replace or repair any of its LCD which is found defective electrically or visually when inspected in accordance with YB GENERAL LCD INSPECTION STANDARD.

15. Guarantee:

Our products meet requirements of the environment.

YEEBO ROHS requirement is based on European Union Directive 2011/65/EU (ROHS) Requirements and Update.